

KENWOOD

TS-480HX/SAT

KENWOOD NETWORK COMMAND
SYSTEM Setting Manual

JVCKENWOOD Corporation

© January/30/2019

CONTENTS

1. Relevant Models.....	2
2. Objectives of this document	2
3. Outline	3
3.1. Overall Configuration	3
3.2. Outline of Host Station (Transmitter) Operations	4
3.3. Host Station (Transmitter) Configuration	5
3.4. Outline of Remote Station (Operator) Operations	7
3.5. Remote Station (Operator) Configuration	8
4. Settings.....	10
4.1. Connecting a Communications Cable	10
4.2. Connecting an Audio Cable.....	10
4.3. Transceiver Settings.....	12
4.4. Setting Transmission Methods for Audio Input to the DATA Connector.....	13
4.5. Setting a Broadband Router	14
4.6. Software Installation and Settings.....	15
4.7. Windows Firewall Settings.....	16
4.8. Comprehensive Security Software Settings.....	16
4.9. Making the Host Station Connection Request Wait Mode	16
4.10. Connecting to the Host Station from the Remote Station	16
5. Limitations Caution!	17
5.1. PC Environment Limitations	17
5.2. Network Environment Limitations.....	17
5.3. Program Limitations.....	17
6. Frequently Asked Questions.....	18

Disclaimer:

All efforts have been made regarding the accuracy of the contents described in this document. However, there is a possibility of misprints and of descriptions that may cause misunderstanding. JVC KENWOOD Corporation bears absolutely no responsibility for damages arising thereof.

JVC KENWOOD Corporation may revise and amend the product information described in this document without notice. JVC KENWOOD Corporation bears absolutely no responsibility for damages arising thereof.

- Windows is a registered trademark or trademark of Microsoft Corporation in the United States and other countries.
- Bluetooth is a registered trademark or trademark of Bluetooth SIG, Inc.
- SoundBlaster is a registered trademark or trademark of Creative Technologies Ltd. in the United States and other countries.
- The names of all products described hereafter are the trademarks or registered trademarks of their respective manufacturers.
- ® and ™ are omitted throughout the text.

1. Relevant Models

This operations guide is for the TS-480 series (TS-480HX and TS-480SAT).

Using the TS-480 series (hereinafter called "TS-480") and KENWOOD NETWORK COMMAND SYSTEM (hereinafter called "KNS") enables transceiver operations by remote control using a home LAN or the Internet.

KNS is a system configured using PCs, network environments, ARCP-480 (a Radio Control Program) (hereinafter called "ARCP-480"), ARHP-10 (a Radio Host Program) (hereinafter called "ARHP-10"), and ARVP-10 (a VoIP Program) (hereinafter called "ARVP-10") for remote control of the TS-480.

Important

- To configure the system, knowledge not only of transceivers but also of PCs and networks is required. JVC KENWOOD Corporation does not offer support for customer PCs and Networks. Furthermore, for operations relating to actual transmitting, note that procedures according to the Radio Act are also required.
- Operations via networks may be delayed due to unavoidable principles. Consequently, do not perform operations (such as contests or pile-ups requiring quick responses) for which delays are likely to be a problem.
- Refer to "[5. Limitations Caution!](#)" for other limitations.
- JVC KENWOOD Corporation shall bear no responsibility for related damage such as damage caused by missed communications and dialog opportunities due to incorrect customer settings, nonconformances, or misoperations as a result of using this document or the ARCP-480, ARHP-10 or ARVP-10 software.

2. Objectives of this document

To supply information to configure a remote control system via a home LAN or Internet using the TS-480, ARCP-480, ARHP-10 and ARVP-10.

The following describes the main elements.

	Via Internet	Home LAN
Programs used	ARCP-480 (Operates transceiver remotely.) ARHP-10 (Exists between the ARCP-480 and transceiver, and control it.) ARVP-10 (Transmits and receives audio)	ARCP-480 (Operates transceiver remotely.) ARHP-10 (Exists between the ARCP-480 and transceiver, and control it.) ARVP-10 (Transmits and receives audio)
Network	Connection via the Internet (To use the Internet, a contract with a provider is necessary.)	Connection using the home LAN
IP address used	Global IP address	Local IP address
Application based on the Radio Act	Application using the Internet	Application using the home LAN

3. Outline

3.1. Overall Configuration

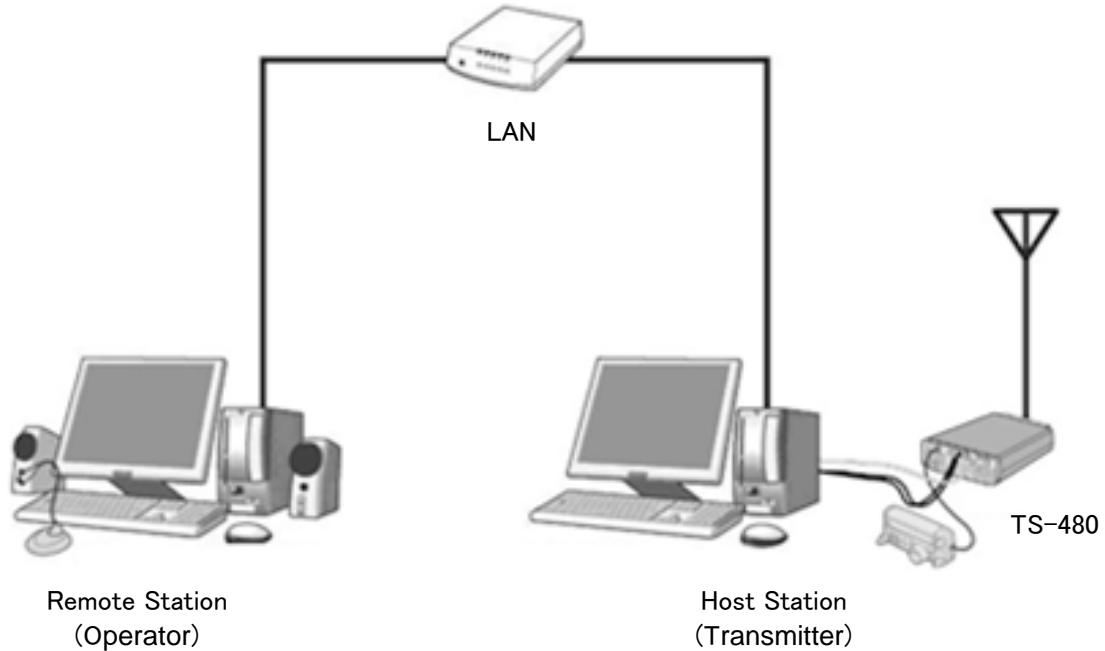

Fig. 3.1.1: Example of a home LAN configuration
(In this diagram, the modem, router, and hub have been omitted.)

As shown in the diagram, the configuration uses a host station (where the transceiver is installed; this is called the "transmitter" in the Radio Act) and a remote station (which performs the remote operations; this is called the "operator" in the Radio Act). A PC is connected to both, and the PCs are connected to each other via the network.

The transceiver connected to the PC to which the ARHP-10 has been installed on the host station is operated using the ARCP-480, which has been installed on the remote station PC. Furthermore, transmitted and received audio for the transceiver on the host station can be transmitted and received using the ARVP-10 to and from the microphone and speaker connected to the PC sound device on the remote station.

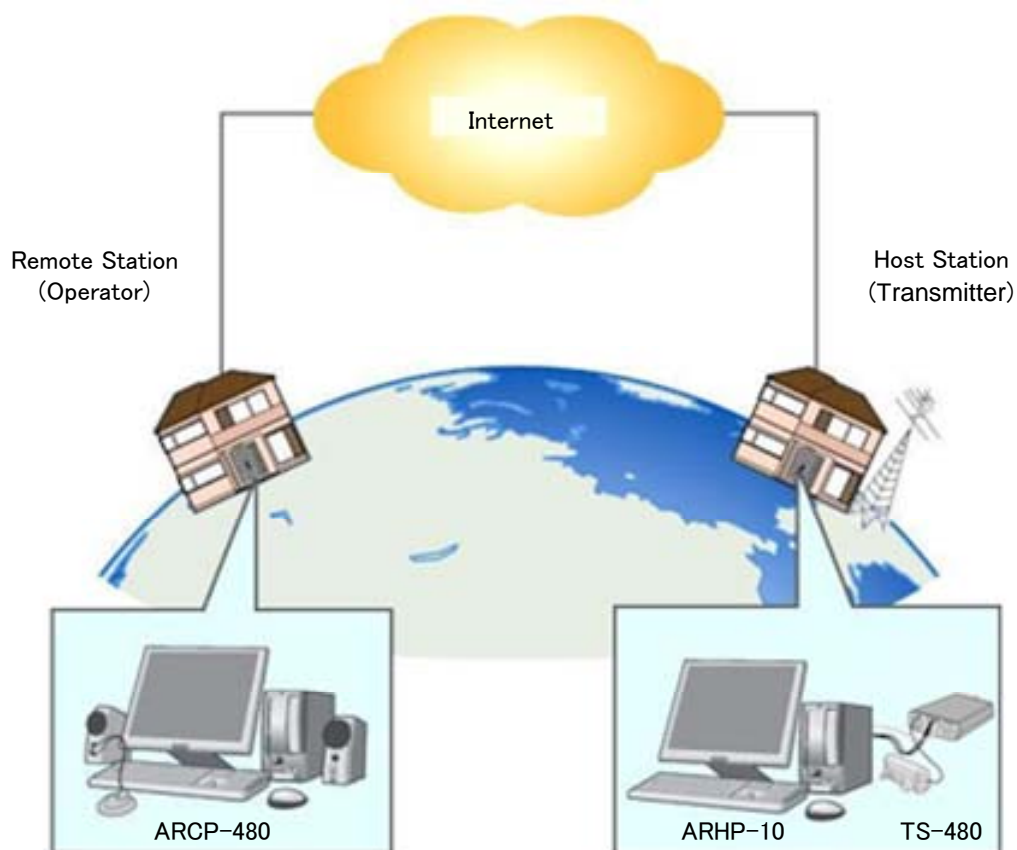

Fig. 3.1.2: Example of a KNS configuration via the Internet

The host station and remote station can be installed in any location with a home LAN connection or Internet connection.

3.2. Outline of Host Station (Transmitter) Operations

The host station is configured using a transceiver and a PC connected to the network. Data signals that control the transceiver are connected to the PC using an RS-232C. The PC uses its sound function to input and output audio transmitted and received by the transceiver, and converts them between digital and analog signals.

The ARHP-10 and ARVP-10H are installed on the PC. The ARHP-10 exchanges transceiver control data signals with the network. The ARVP-10H is a VoIP program and exchanges audio transmissions with the network.

The ARVP-10 includes both of the ARVP-10H for the host station and the ARVP-10R for the remote station.

When the ARVP-10 does not work on your PC, operating system, or network environment, you may use a commonly-used VoIP software (such as a P2P telephony software) for making voice communications via a network instead of the ARVP-10. (You are responsible for the selection, installation and operation using the VoIP software.)

The PC is connected to the network, and exchanges transceiver control data signals and audio transmissions with the "Remote station (operator)" on the network.

3.3. Host Station (Transmitter) Configuration

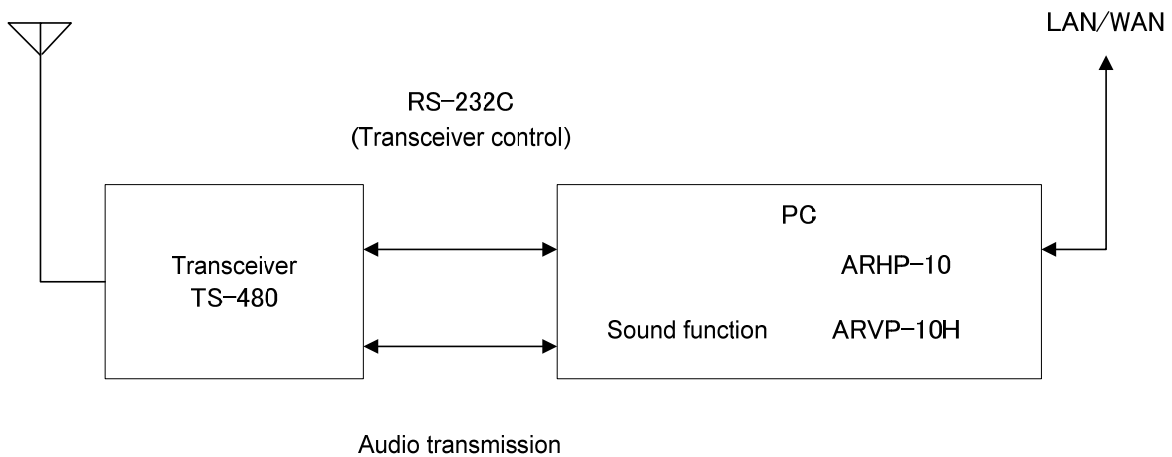

Transceiver	TS-480	The TS-480 transceiver is supported. The ARCP-480 and ARHP-10 are specialized for the TS-480, thus other transceivers cannot be used to configure the system.
Connection	RS-232C	Controls that change the frequency or mode are performed by connecting the transceiver and PC using an RS-232C cable. (The transceiver has only one RS-232C connector (COM connector), so if you are using the RS-232C connector (COM connector) for KNS operations, another device cannot be connected.)
	Audio	The audio cable is created by the customer. To exchange audio transmissions, connect the transceiver DATA connector to the PC sound I/O terminal. For the transceiver connector specifications, refer to the TS-480 instruction manual, and for the cable creation and connection methods, refer to " 4.2. Connecting an Audio Cable ".
PC	Specifications	CPU and memory: Minimum values recommended by the operating system. HDD: To install both the ARHP-10 and the ARVP-10, a minimum of approx. 100 MB of free disk space is required. If saving connection logs, additional memory space is required.
	Sound function	To exchange audio transmissions, a sound function is required. Sound Blaster 16 or higher is recommended. For the sound functions in comprehensive chipsets, the sound transmission may not be exchanged normally in some cases.
	Network function	Connects to the home LAN. To perform KNS operations via the Internet, connect to a network that is connected to the Internet. A wired network is recommended.

Software	Operating System	Windows 7 (32-bit or 64-bit) Windows 8.1 (32-bit or 64-bit) Windows 10 (32-bit or 64-bit) (See Note 1 and Note 2.)
	ARHP-10	This software controls the transceivers. Refer to the software help for the settings and operation methods. Download the software from the website, and install it onto the PC. https://www.kenwood.com/i/products/info/amateur/software_download.html
	ARVP-10	This software exchanges audio transmissions. Refer to the software help for the settings and operation methods. Download the software from the website, and install it onto the PC. https://www.kenwood.com/i/products/info/amateur/software_download.html
LAN environment	Broadband router	To implement KNS operations via the Internet, a model on which port forwarding settings are possible using the following protocol is required to transmit the data signals that control the transceiver and audio. (See Note 3.) Protocol: TCP; port No.: 50000 (ARHP-10 default value) Protocol: UDP; port No.: 33550 (ARVP-10 default value)
	Modem	Not specified.
	Firewall	To implement KNS operations via the Internet, firewall environments configured using in-house company networks cannot be used. Use a home LAN environment.
Internet environment	Provider	To implement KNS operations via the Internet: <ul style="list-style-type: none"> • A high-speed wired broadband environment using xDSL, FTTH, or CATV network is required. (1Mbps min. recommended.) • A global IP address is required. (See Note 4.) • The ability to use protocols and ports to transmit the data signals that control the transceiver and audio is required. Protocol: TCP; port No.: 50000 (ARHP-10 default value) Protocol: UDP; port No.: 33550 (ARVP-10 default value) For details, contact your Internet service provider.
	Proxy	A proxy server cannot be used.

Note 1 The operating systems listed in the table are compatible with the software even if some of them are not listed in the software help file due to the release date.

Note 2 Applicable operating systems are subject to change without notice due to the end of the technical support by Microsoft Corporation or change of the product specifications.

Note 3 Refer to the user's manual for the broadband router to be used before performing the settings.

Note 4 KNS operations are possible even if the global IP address is variable, but the IP address may change with uncertain timing. In such cases, it is necessary to check and change the IP address of the connected host when connected from a remote station, which reduces user-friendliness. Consequently, using an environment in which the host station global IP address is fixed is recommended. Furthermore, if the global IP address cannot be fixed, using a dynamic DNS service enables operations in the same way as an environment with a fixed global IP address.

3.4. Outline of Remote Station (Operator) Operations

The remote station is configured using a PC connected to the network, and a microphone and speaker connected to the PC sound function. The audio transmissions for the host station transceiver are input and output using the microphone and speaker connected to the sound function of the remote station PC via the network.

The ARCP-480 and ARVP-10R are installed on the PC. The host station transceiver connected via the network is controlled by the remote station ARCP-480 operations. The ARVP-10R is a VoIP program and supplies the transceiver with the transmitted and received audio of the host station side to the microphone and speaker of the PC of the remote station side.

The ARVP-10 includes both of the ARVP-10H for the host station and the ARVP-10R for the remote station.

3.5. Remote Station (Operator) Configuration

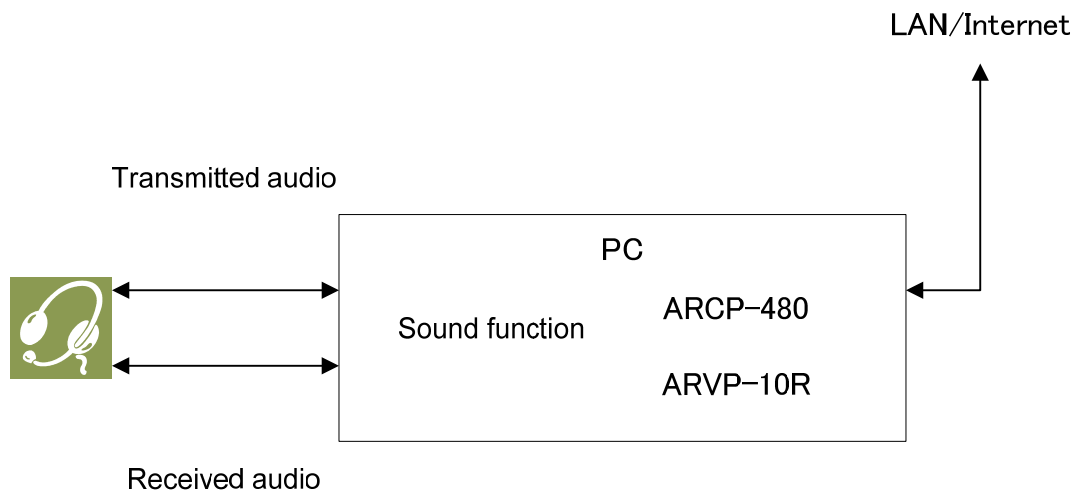

Connection	Audio	To exchange audio transmissions, connect the microphone and speaker, or a headset to the PC sound function. Use products compatible with the sound function used.
PC	Specifications	CPU and memory: Minimum values recommended by the operating system. HDD: To install both the ARCP-480 and the ARVP-10, a minimum of approx. 100 MB of free disk space is required. If saving transceiver settings to data files, or saving keying logs, additional memory space is required.
	Sound function	To exchange audio transmissions, a sound function is required.
	Network function	Connects to the home LAN. To perform KNS operations via the Internet, connect to a network that is connected to the Internet. A wired network is recommended.

Software	Operating System	Same as host station.
	ARCP-480	This software remote controls the transceivers. Refer to the software help for the settings and operation methods. Download the software from the website, and install it onto the PC. https://www.kenwood.com/i/products/info/amateur/software_download.html
	ARVP-10	This software exchanges audio transmissions. Refer to the software help for the settings and operation methods. Download the software from the website, and install it onto the PC. https://www.kenwood.com/i/products/info/amateur/software_download.html
LAN environment	Broadband router	Same as host station.
	Modem	Same as host station.
	Firewall	Same as host station.
Internet environment	Provider	Same as host station.
	Proxy	Same as host station.

4. Settings

4.1. Connecting a Communications Cable

Connect the host station PC and TS-480 using an RS-232C cable.

Note: The RS-232C cable is sold separately. Purchase them from a commercial retailer.

Connect the PC and TS-480 using the RS-232C straight cable (9 pin to 9 pin).

4.2. Connecting an Audio Cable

To transmit and receive audio, an audio cable is required. Create an audio cable using the 6-pin Mini DIN plug enclosed with the TS-480 with reference to the following diagram. For details of the connector specifications, refer to the TS-480 instruction manual.

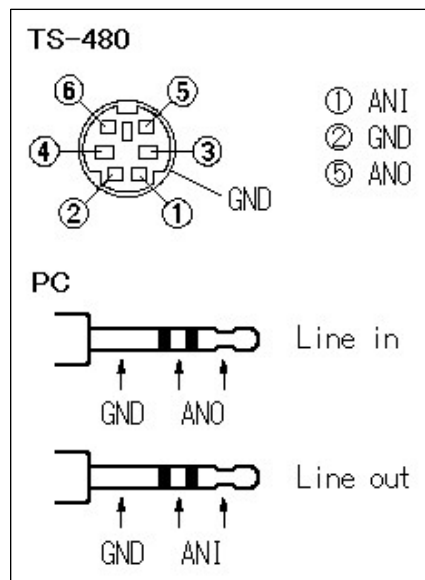

Fig. 4.2.1: Creating an audio cable

Connect the PC sound functions and audio cable with reference to the following diagram.

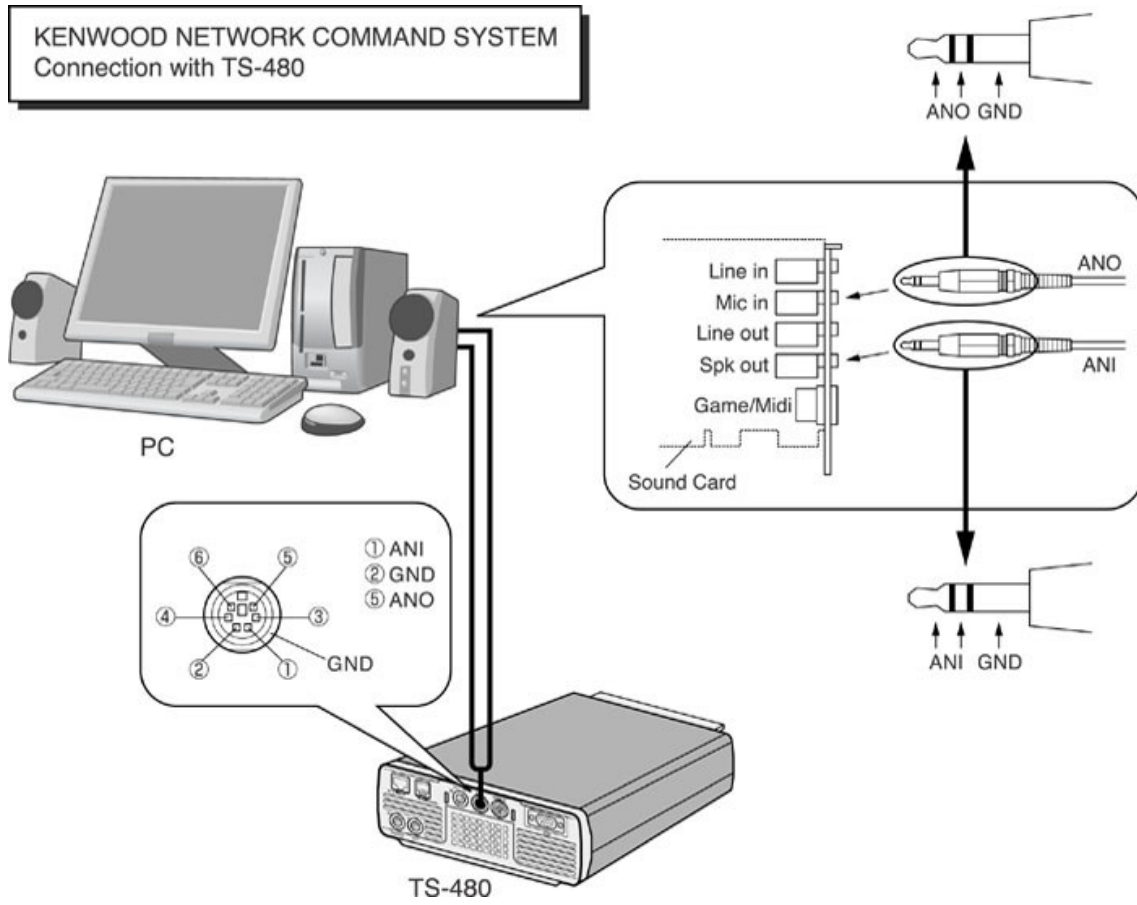

Fig. 4.2.2: Connecting audio cables

4.3. Transceiver Settings

Make the settings required to implement KNS operations using transceivers.

- Data VOX settings

With the TS-480, VOX functions can be implemented using audio input to the DATA connector, but to prevent unintentional transmission during KNS operations, turn OFF the function using the menu settings.

Menu No.	Function	Set value
60	Transmit with the audio input on the DATA terminal	OFF

The default setting is OFF.

Caution:

- There is a risk that sounds other than those produced by the PC may be transmitted unintentionally over the network, so we recommend that you turn off this function.
- When this function is ON, be aware that all sounds created by the PC other than the intended audio transmissions are also transmitted.
- When using this function for the first time, we recommend connecting a dummy load to the TS-480 to perform checks and adjustments.

- Audio I/O level settings

Use the following menu to adjust audio transmission input levels from the PC, and receive audio output levels to the PC.

Menu No.	Function	Setting range
46	AF input level for Data communications	0~9
47	AF output level for Data communications	0~9

The default value for all settings is 4.

Reference:

Adjust the Windows sound function volume as necessary.

- Timeout timer settings

During KNS operations, control data signals are transmitted using the network. Consequently, if normal network operations are disabled for any reason, control of the transceiver will also be disabled. Use the following menu to set the functions to stop transmitting automatically after a fixed period if control should be disabled while transmitting.

Menu No.	Function	Set value
22	Time-out timer	except OFF (See Note)

The default setting is OFF.

Note: Select from 3/ 5/ 10/ 20/ 30(minutes) excepting OFF, depending on the situation to use.

- Prohibit transmission setting

If using the host station as a receive-only station, set to transmission inhibited. Make the settings using the following menu.

Menu No.	Function	Set value
55	TX inhibit	ON

The default setting is OFF.

4.4. Setting Transmission Methods for Audio Input from the DATA Connector.

The PTT of the microphone connected to the TS-480 is the method for transmitting audio input from the microphone connected to the TS-480, so even if this operation is implemented, audio input as audio signals from the DATA connector cannot be transmitted.

To transmit audio input as audio signals from the DATA connector, select one of the following methods.

- Transmitting using the ARCP-480
With the ARCP-480, settings must be performed to transmit audio input from the DATA terminal to use the on-screen [SEND] button.

Select "Setup" from the ARCP-590 "Control" menu. The "Setup" window is displayed.

In this window, select "DTS" in the "TX Control".

For details, refer to the ARCP-480 help.

- Transmitting using the DTS terminal in the DATA connector
Audio input from the DATA connector can be transmitted by setting the DTS terminal in the DATA connector on the rear of the TS-480 to low.

For details of the connector and terminal specifications, refer to the TS-480 instruction manual.

4.5. Setting a Broadband Router

If implementing KNS operations via the Internet, it is necessary to set the broadband router connected to the host station.

Make the settings to transmit control data signals transmitted and audio transmissions via the Internet from the broadband router to the host station PC.

This setting depends on the call method of the broadband router manufacturer, and may be "Port forwarding", "IP masquerade", "Port conversion", "NAT address conversion", etc. Refer to the user's manual for the broadband router used.

The settings are described below.

Control data signals

Item (Example)	Setting Details
Open IP address	IP address of the PC used in the host station
Protocol	TCP
Port Number	50000 (default value)
Direction	Two-way

Audio transmissions

Item (Example)	Setting Details
Open IP address	IP address of the PC used in the host station
Protocol	UDP
Port Number	335050 (default value)
Direction	Two-way

Caution:

- For the broadband router settings, refer to the broadband router user's manual.
- Incorrect broadband router settings may stop the network or enable illegal external access to the network. Take thorough precautions when changing the settings.
- JVC KENWOOD Corporation does not offer support for customer PCs and networks.

4.6. Software Installation and Settings

Install the software required for KNS operations on the host station PC and the remote station PC, and then perform the required settings.

- Host station PC

Download and install the ARHP-10 onto the PC from the Kenwood website:
https://www.kenwood.com/i/products/info/amateur/software_download.html

Make the COM port settings used to connect to the TS-480, network settings, optional settings, and user settings by selecting the "Control" menu and then "Setup" in the ARHP-10. For the settings methods, refer to the ARHP-10 help file.

Download and install the ARVP-10 onto the PC from the Kenwood website:
https://www.kenwood.com/i/products/info/amateur/software_download.html

The ARVP-10 includes both of the ARVP-10H for the host station and the ARVP-10R for the remote station.

- Remote station PC

Download and install the ARCP-480 onto the PC from the Kenwood website:
https://www.kenwood.com/i/products/info/amateur/software_download.html

In the ARCP-480, select the "Control" menu and then "Setup", and set the connection to "Use Network Command System". Click the "Setting" button to make the "KNS connection settings". For the settings methods, refer to the ARCP-480 help file.

Download and install the ARVP-10 onto the PC from the Kenwood website:
https://www.kenwood.com/i/products/info/amateur/software_download.html

The ARVP-10 includes both of the ARVP-10H for the host station and the ARVP-10R for the remote station.

Caution:

- For audio transmissions, this can replace it with general purpose VoIP software as well as the ARVP-10. Refer to the VoIP software for details.
- Support for selecting, installing, and operating VoIP software is not available from JVC KENWOOD Corporation.

4.7. Windows Firewall Settings

With the host station PC, receiving connections from networks and the Internet using the ARHP-10 and ARVP-10 are blocked by the Windows firewall. When blocked, KNS operations are disabled, so remove the block.

Reference:

Add the ARHP-10 and ARVP-10H to "exceptions" using the Windows firewall settings to release the block.

4.8. Comprehensive Security Software Settings

If using comprehensive security software, it is necessary to adjust the settings so that ARHP-10, ARCP-480 and ARVP-10 communications are not blocked. Perform the settings with reference to the user's manual for the comprehensive security software used.

4.9. Making the Host Station Connection Request Wait Mode

Click the "CON" button in the main window of the ARHP-10 on the host station. The indicator will light yellow and the host station will enter connection request wait mode.

Click the "Online" button in the main window of the ARVP-10H on the host station. The notation of the "Online" button changes to "Offline" and the host station will enter connection request wait mode.

4.10. Connecting to the Host Station from the Remote Station

Click the "CON" button in the main window of the ARCP-480 on the remote station. If the connection to the host station is successful, the indicator will light green.

Click the "Connect" button in the main window of the ARVP-10R on the remote station. If the connection to the host station is successful, the indicators will light green and red.

5. Limitations **Caution!**

5.1. PC Environment Limitations

The ARCP-480, ARHP-10, and ARVP-10 are compatible with the Windows 7 (32-bit or 64-bit), Windows 8.1 (32-bit or 64-bit), or Windows 10 (32-bit or 64-bit). Use the operating systems described above for both the host and remote stations.

Applicable operating systems are subject to change without notice due to the end of the technical support by Microsoft Corporation or change of the product specifications..

For KNS operations, it is necessary to set and change the open broadband router ports, Windows firewall functions, and comprehensive security software. Furthermore, it is the customer's responsibility to handle security when using this system. If you do not have confidence in the settings, we recommended you stop using the system.

5.2. Network Environment Limitations

During KNS operations via the Internet, it is necessary to set the global IP address on the host station. For your global IP address, consult your contracted provider.

Only registered people can access the host station using their ID and password. Make sure that the ID and password settings cannot be guessed easily by unauthorized people.

On this system, signals are exchanged via the network. Consequently, smooth operations may be disabled compared to normal transceiver operations as delays (during analog/digital conversions) and data loss (which is greatly dependent on traffic) are unavoidable. This is the principle operation of the system.

Examples are cited below.

Audio may break up, meter deflection may not be smooth, standby time may be delayed (in particular, it is not suitable for contests or quick operations such as pile-ups). VFO variability may not be smooth, audio may differ from the actual transceiver audio and digital mode communications such as image communications with SSTV and AFSK, PSK-31, etc., may be disabled, etc.

Broadband is recommended for the Internet line used. As a benchmark, use a minimum of 1 Mbps. The speed of analog modems that use telephone lines will greatly reduce sound quality, and may destabilize control, and so cannot be used.

5.3. Program Limitations

CW operations are possible, but keying using normal e-keys is not possible. Strings entered using the keyboard are collated for transmit operations.

When connecting using the DATA connector to exchange audio transmission recommended in this document, the transceiver PROC function is not available. (The indication changes, but the PROC function does not work.) This works only for the signal which the PROC function was input into by a MIC connector.

6. Frequently Asked Questions

This section introduces questions that have been asked to date, and subjects verified by JVC KENWOOD Corporation.

	Question	Answer
Installation	When using a network connection via the Internet, is KNS disabled unless I obtain a global IP address?	When using a network connection via the Internet, a global IP address is required.
	I have a variable global IP address for the host station. Can I still use it?	A variable global IP address can also be used, but each time the global IP address changes, you must reset the settings, which is inconvenient. We recommend using a fixed global IP address. Even with a variable global IP address, the inconvenience of resetting the settings can be eliminated by using a dynamic DNS service, which can be used in the same way as a fixed global IP address.
	I use CATV Internet. Can I use KNS via the Internet?	If you can obtain a fixed global IP address, yes. If using a type with the broadband router built into the cable model, it is possible if port forwarding settings can be made.
	Can I use environments with a proxy or firewall on the host station or the remote station or both sides?	A proxy and firewall environment cannot be used. Both the host station and the remote station can be used only on general home network environments.
	Can I use a wireless LAN or BWA (broadband wireless access)?	We do not recommend this, as line speeds are not fixed for best effort-type wireless.

	Question	Answer
Installation	On the former website, there was a specified router type. Is this no longer the case?	With the ARCP-480 and ARHP-10 combination, there were cases where sound did not pass depending on the type of router and Windows update. Because this problem cannot be settled on the application software side, we developed the new ARVP-10 and decided to accommodate it by offering the application software that was not dependent on the router type and the Windows specifications as much as possible.
	I want to use a USB headset or Bluetooth headset on the remote station PC. Will there be any problems?	<p>You can use them, but in principle, a USB headset or Bluetooth headset has unavoidable delays, so entering standby will take considerable time. If the delays are a problem, it is better to avoid using them.</p> <p>After connecting a USB headset or Bluetooth headset, you must set the default recording and playback devices using the Windows sound settings. For details, refer to the USB headset or Bluetooth headset user's manual.</p>

	Question	Answer
Internet	Cannot operate the transceiver. Cannot connect to the host station.	<p>Check that connections to websites and your Internet mail server are still possible. Check the host station IP address, ID, and password.</p> <p>If there are no problems, check the following.</p> <ul style="list-style-type: none"> • Check that the port used for transceiver control (TCP/default setting: 50000) and audio transmissions (UDP/default setting: 33550) are set to open on the host station broadband router. • Check that there are not two or more broadband routers (hereafter called "BBR") on the host station network. If there are two or more BBRs, either open the port required by KNS for either of the BBRs, or stop one of the BBRs and make sure that only one BBR exists on the network, and then set the required KNS port to open on the BBR. (Refer to "(Supplement): FAQ: Explaining the Internet "Cannot operate transceiver".")

	Question	Answer
Operating System	When attempting a KNS connection, a warning message may be displayed by the Windows.	Add ARHP-10 and ARVP-10 to the Windows firewall exceptions.
Operations	Why can't I use the ARCP-990?	The ARCP-990 is for the TS-990S only. Use the ARCP-480 with the TS-480.
	Why can't I use the ARHP-990?	The ARHP-990 is for the TS-990S only. Use the ARHP-10 with the TS-480.
	Reception sound quality is different from the TS-480 itself.	Audio via a network is affected by the audio encoding and data bandwidth, and so sound quality may differ from the actual received quality. These are VoIP specifications, and cannot be improved.
	I want to control an antenna rotator or peripheral device other than the transceiver.	The current system is compatible only for transceiver control.

	Question	Answer
Operations	There are so many limitations. Can this system operate?	<p>Although different from normal operations, considerably practical operations are possible in ordinary communications.</p> <p>There may be some initial confusion over the standby timing until you are familiar with the specific delays via the network. We recommend first becoming familiar with the transceiver operations from the PC using a single ARCP-480, and then attempting operations on a network environment as the next step.</p> <p>When attempting actual operations, unless operating with a partner, the Internet remote operation is hard to understand.</p>
	Audio transmissions are noisy or small. Where should I check and adjust?	Adjust the DATA audio level in menus 46 and 47.
		Try changing the sound function driver version.
		If using the sound functions in comprehensive chipsets, try an independent sound card or USB sound. Sound Blaster 16 or higher is recommended.
	The operation of the transceiver is possible, but sounds do not pass. The sound breaks off for an instant, periodically.	Try changing the sound function driver version. It is confirmed that whether sound is passed or not depends on the version of the sound functions driver.
		If using the sound functions in comprehensive chipsets, try an independent sound card or USB sound. Sound Blaster 16 or higher is recommended.

	Question	Answer
Operations	When time passes, sounds do not pass.	With the ARCP-480 and ARHP-10 combination, there were cases where when they combined some broadband routers, the phenomenon that sounds did not pass when time stood occurred. Because this problem cannot be settled on the application software side, we developed the new ARVP-10 and decided to accommodate it by offering the application software that was not dependent on the broadband router type as much as possible.
	Can I set the PC to sleep mode while I'm not using the host station? When a fixed time has elapsed without the host station being used, the host station PC screen turns OFF, and responses to connection requests from the remote station cannot be made.	Recovery from sleep mode takes time. During sleep mode recovery, responses to the remote station cannot be returned until there is a time out. Therefore, we recommend you do not set the host station to sleep mode.
	If there is a connection request from the remote station while the host station is not being used, a message is displayed and connections to the host station are disabled.	Is the Windows energy save mode operating, and has the power supply to the host station HDD been disabled? When the HDD power supply is turned OFF, the HDD power supply is turned ON to respond, but at this time nothing can be returned until the response to the remote station has timed out. Consequently, set the Windows power supply function settings so that the HDD power supply does not turn OFF.
	An audio I/O between the host station PC and transceiver cannot be performed correctly.	Check that a default device is specified as the device connected to the TS-480 using the Windows sound settings on the host station PC.
	The modulation is not performed even when the ARCP-480 "SEND" button is pressed.	Check that the same path as the modulation path wired between the transceiver and the PC has been selected using the ARCP-480 "Setup" menu.

	Question	Answer
Operations	Cannot exchange the audio transmission correctly between the remote station and the host station.	Refer to the ARVP-10 help, and check the settings.
		Check that a default device has been specified for the PC speakers, microphone, or headset currently in use, using the Windows sound settings on the remote station PC.
		Check whether the PC microphone or headset has been muted or is at low volume.
		Check that the PC, speakers, microphone, and headset are connected correctly.
	The audio transmission keeps varying in volume and is not constant.	Has the AGC been turned ON using the VoIP software input audio settings? For details, refer to the VoIP software user's manual, and check the settings.
	The final part of the audio transmitted from the host station transceiver is missing.	If you return to receiving operations immediately after the conversation has finished using the remote station, you may switch to receiving before all the audio has been transmitted due to the audio transmission delay.
Comprehensive security software, etc.	I'm using comprehensive security software, but when I try a KNS connection, the warning "Software is attempting to connect to the Internet" is displayed. Can I press the "Block" button?	Refer to the user's manual for the comprehensive security software being used, and set it so that the communications of the port used by ARCP-480, ARHP-10 and ARVP-10 are not blocked.
Others	When playing audio and video when implementing KNS operations on the PC used as the host station, the audio is transmitted from the TS-480.	During KNS operations, all audio output from the PC is input to the TS-480 as transmitted audio. During KNS operations, do not play audio or video. Furthermore, we recommend terminating other programs.
	Loud sounds are suddenly output from the host station transceiver.	The cause is the remote station user operating the volume control.

(Supplement): FAQ: Explaining the Internet "Cannot operate transceiver"

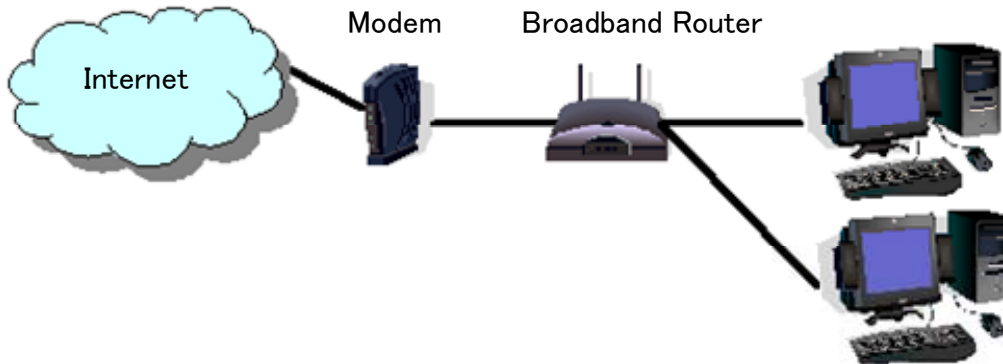

Fig. 1

As shown in Fig. 1, even though only one broadband router (BBR) is visible on the network, in reality there are two. (Duplex router phenomenon.)

There are multiple modems with built-in BBR functions, so when connecting such a modem as described above, there must not be two BBR paths connecting the PC to the Internet.

Consequently, even if the open port has been set for one BBR only, the required KNS packets will not flow. For this reason, either set the required KNS port to open for two BBRs, or stop one BBR function, and set the network so that there is only one BBR on the network.

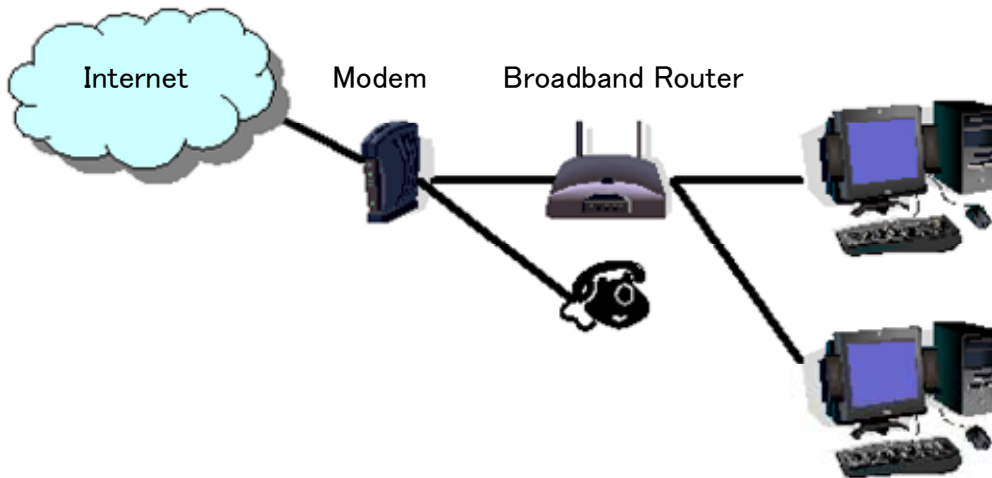

Fig. 2

As shown in Fig. 2, the case where a telephone is connected directly to a modem, in most models the modem has a built-in BBR function. In such cases, stopping the function of the BBR built into the modem stops the VoIP telephone functions connected to the modem, so VoIP telephony use is disabled.

To prevent the VoIP telephone functions from stopping, stop the functions of the BBR connected to the front of the PC, and set the port required by KNS to open in the BBR built into the modem.

Caution:

Change any settings such as open BBR ports at your own risk.
If you do not have confidence in the settings, we recommend you stop using the system.